

**Note:** Model HV front blades parallel to the horizontal dimension  
Model VH front blades parallel to the vertical dimension

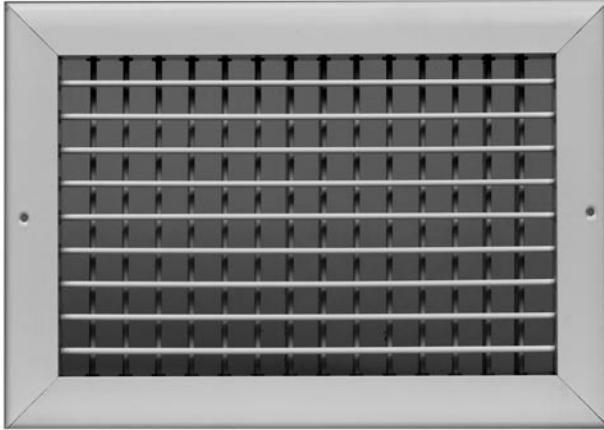

model HV

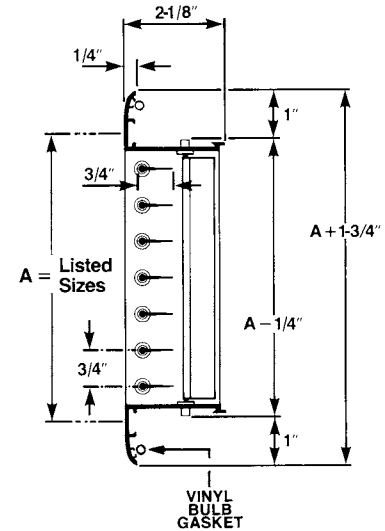

### Listed Sizes

horizontal dimensions		vertical dimensions	
(ins)	(mm)	(ins)	(mm)
4	102	4	102
6	153	6	153
8	204	8	204
10	254	10	254
12	305	12	305
14	356	14	356
16	407	16	407
18	457	18	457
20	508	20	508
22	559	22	559
24	610	24	610
26	660		
28	711		
30	762		
32	813		
34	864		
36	915		
38	965		
40	1006		
42	1067		
44	1117		
46	1168		
48	1219		
50	1270		
52	1321		
54	1372		
56	1422		
58	1473		
60	1524		

### product description

Frame and blades are 6063 extruded aluminum alloy with 200-R1 satin anodized finish. The frame has a typical wall thickness of .050" and is separated from the blades with injection-molded nylon bushings ... this method of assembly eliminates corrosion and vibration. The frame mounting holes are dimpled, allowing for a counter-sunk fastener head appearance.

All blades are airfoil in design, individually adjustable and spaced 3/4" on center. At the outer edge of the frame is a specially engineered channel which retains an extruded flexible vinyl bulb gasket that produces a positive air seal at the mounting surface, minimizing smudging.

An optional opposed blade damper is screwdriver-operated through the face of the unit, and has the same extruded aluminum construction and injection-molded nylon bushings.

The unit achieves an effective area of 80% with the blades set at a 0° pattern, thus eliminating high velocity and pressure drop at the grille face. Wider deflection with reduced throw may be achieved at the 22° and 45° blade settings with slightly increased noise levels.

Suitable for sidewall application.

Available in clear anodized, white or a variety of custom colors.

### available options

### depth of unit

### test data

#### HV, VH

Double deflection grille with individually adjustable horizontal and vertical blades.

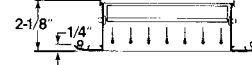

TD  
1-4

#### HV-OB, VH-OB

Double deflection register with individually adjustable horizontal and vertical blades with opposed blade damper.

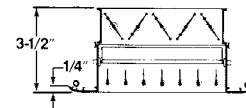

TD  
1-4

#### HV-PF, VH-PF

Double deflection grille with individually adjustable horizontal and vertical blades with plaster frame.

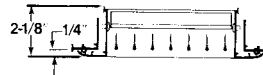

TD  
1-4

#### HV-OB-PF, VH-OB-PF

Double deflection register with individually adjustable horizontal and vertical blades with opposed blade damper and plaster frame.

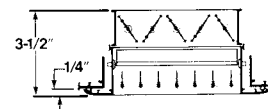

TD  
1-4

#### HV-OB-FL, VH-OB-FL

Double deflection register with individually adjustable horizontal and vertical blades with opposed blade damper and fire link.  
(Fire link only is UL-listed.)

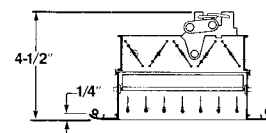

TD  
1-4

Sizes other than shown are available.

AIRGUIDE MANUFACTURING  
795 WEST 20<sup>TH</sup> STREET  
HIALEAH, FLORIDA 33010  
PHONE: (305) 888-1631